

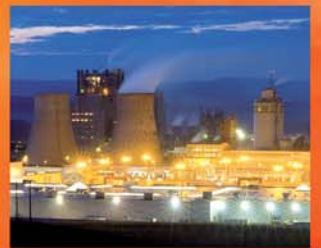

Pro for life



Non-sparking tools

Outillage antidéflagrant - Herramientas antichispa - Искробезопасный инструмент





FACOM ADF



New "FACOM ADF" non-sparking tool range

The FACOM ADF tool range has been designed for use in explosive or flammable atmospheres, where "traditional" steel tools may accidentally create sparks due to friction, impact, or by falling on a hard surface.

The entire FACOM ADF range is made from a special Copper - Beryllium alloy having better mechanical properties than the other alloys proposed for use in explosion-proof tools. In addition to its explosion-proof properties, the Cu-Be alloy is also anti-magnetic and highly corrosion resistant. Having a lower density, it also significantly reduces user fatigue.

FACOM ADF tools have been designed in accordance with the most widely used dimensional standards (ISO, DIN, BSI, NF, etc.) or adapted to perform the tool's main functions.

FACOM ADF tools can be used in a wide variety of fields, such as:

- Mining
- Petrol and gas extraction (off-shore and on-shore)
- Refineries, petrochemicals
- Pipeline maintenance
- Energy production and transport (gas, electricity, etc.)
- Naval shipyards
- Aeronautical transport, airports
- Paint manufacture
- Manufacture of explosives & flammable products
- Arsenals, munitions and explosive products storage
- Applications requiring demagnetised tools (metal shavings, etc.)
- Farming - Grain silos
- ...

Safety

- Non sparking tools is not enough for protecting from an explosion, other items adapted to the environment are necessary, such as: clothes, gloves, safety glasses and adapted materials.
- Tool's surface temperature must not be more than present gases temperature.
- Cu-Be alloy tools must not be in contact with acetylene (risk of spark).
- All Cu-Be alloy tools, in the state of finished product, presents no risk for the user. On the other hand any modification of these tools presents a risk of Cu-Be alloy particles liberation, harmful for the health.

- The certificate TUV (n°TUV-F 09 ATEX 0005 X) have been found to comply with standard for a use in explosive atmospheres and with the Essential Health and Safety Requirements following 1127-1, EN 13463-1 (2007) et EN 13463-5 (2003).
- Le certificat TUV (n°TUV-F 09 ATEX 0005 X) atteste de la conformité de la gamme FACOM ADF aux exigences des normes en vigueur pour les milieux explosifs et ce qui concerne la santé et la sécurité, suivant les normes EN 1127-1, EN 13463-1 (2007) et EN 13463-5 (2003).

Nouveau Programme d'outillage Antidéflagrant "FACOM ADF"

L'outillage FACOM ADF a été conçu pour un usage dans une atmosphère explosive ou inflammable, où l'outillage "classique" en acier, par suite de frottement, de chocs ou de chute sur des surfaces dures, peut produire accidentellement des étincelles.

Toute la gamme FACOM ADF est fabriquée dans un alliage spécial Cuivre - Béryllium avec des caractéristiques mécaniques supérieures aux autres alliages proposés dans le domaine de l'outillage antidéflagrant. En plus d'être un alliage antidéflagrant, le Cu-Be est antimagnétique, très résistant à la corrosion et permet, avec un poids spécifique inférieur, une diminution importante de la fatigue pour l'utilisateur. La conception de l'outillage FACOM ADF est conforme aux normes dimensionnelles les plus répandues : ISO, DIN, BSI, NF... ou adaptée pour respecter les fonctions principales de l'outil.

Les outils FACOM ADF peuvent être utilisés dans des univers très variés comme :

- Industries minières
- Extraction de pétrole et gaz (off & on shore)
- Raffineries, pétrochimie
- Maintenance sur pipelines
- Production et transport d'énergie (gaz, électricité...)
- Chantiers navals
- Transport aéronautique, aéroports
- Fabrication de peintures
- Fabrication d'explosifs & produits inflammables
- Arsenaux, stockage de munitions ou produits explosifs
- Domaines nécessitant une désmagnétisation des outils (coqueaux...)
- Agriculture - Silos à grain
- ...

Sécurité

- L'outillage antidéflagrant ne suffit pas pour se protéger d'une explosion, des moyens adaptés à l'environnement sont nécessaires, tels que : vêtements, gants, lunettes de protection et matériaux adaptés.
- La température superficielle de l'outil antidéflagrant ne doit pas dépasser la température d'ignition des gaz en présence.
- Tout outil en alliage Cu-Be ne doit pas être utilisé en présence d'acétylène (risque d'étincelle).
- Tout outil à base d'alliage Cu-Be, à l'état de produit fini, ne présente aucun risque pour l'utilisateur. Par contre toute modification de ces outils présente un risque de libération de particules d'alliage Cu-Be, nuisible à la santé.

Nuevo Programa de herramientas Antichispa "FACOM ADF"

Las herramientas FACOM ADF han sido diseñadas para su uso en una atmósfera explosiva o inflamable, donde la herramienta "clásica" de acero puede producir accidentalmente chispas, a consecuencia de fricciones, choques o caídas sobre superficies duras.

Toda la gama FACOM ADF está fabricada en una aleación especial de Cobre-Berilio con características mecánicas superiores a las demás aleaciones existentes en el mercado de las herramientas Antichispa. Además de ser una aleación antichispa, el Cobre-Berilio es antimagnético, muy resistente a la corrosión y permite al usuario, gracias a un peso específico inferior, reducir la fatiga de forma notable.

El diseño de las herramientas FACOM ADF se ajusta a las normas dimensionales más extendidas: ISO, DIN, BSI, NF, etc., o se adapta para respetar las funciones principales de la herramienta.

Las herramientas FACOM ADF pueden utilizarse en sectores tan variados como:

- Industrias mineras
- Extracción de petróleo y gas (off & on-shore)
- Refinerías, petroquímica
- Mantenimiento de tuberías
- Producción y transporte de energía (gas, electricidad, etc.)
- Astilleros
- Transporte aeronáutico, aeropuertos
- Fabricación de pinturas
- Fabricación de explosivos y productos inflamables
- Arsenales, almacenamiento de municiones o de productos explosivos
- Campos que requieran una desmagnetización de las herramientas (partículas, etc.)
- Agricultura (Silos de grano)
- ...

Seguridad

- La herramienta antichispa no es suficiente para protegerse de una explosión, medios adaptados al entorno son necesarios, tales como: ropa, guantes, gafas de protección y materiales adaptados.
- La temperatura superficial de la herramienta antichispa no debe superar la temperatura de ignición de los gases presentes.
- Cualquier herramienta en aleación Cu-Be no se debe utilizar en presencia de acetileno (riesgo de chispa).
- Cualquier herramienta en aleación Cu-Be, en estado de producto acabado, no presenta ningún peligro para el usuario. Sin embargo, cualquier modificación de estas herramientas presenta un riesgo de liberación de partículas de aleación Cu-Be, nocivos para la salud.

Новая серия взрывобезопасных инструментов "FACOM ADF"

Инструменты FACOM ADF были разработаны специально для использования во взрывоопасной или легковоспламеняющейся среде, где "классические" стальные инструменты вследствие трения, ударов или падения на жесткие поверхности могут случайно вызвать искрение.

Вся гамма FACOM ADF изготовлена из специального сплава Медь - Бериллий, обладающего более высокими механическими характеристиками, чем другие сплавы, используемые в области изготовления взрывобезопасных инструментов. Сплав медь-бериллий, будучи взрывобезопасным, кроме того, является антимагнитным сплавом и очень коррозионностойким, а благодаря его низкому удельному весу пользователь гораздо меньше устает.

Концепция инструментов FACOM ADF соответствует наиболее распространенным стандартам на размеры: ISO, DIN, BSI, NF, ... или адаптируется для соблюдения основных функций инструментов. Инструменты FACOM ADF могут также использоваться в очень разных отраслях, таких как:

- Горнодобывающая промышленность
- Добыча нефти и газа (в море и на суше)
- Нефтеперерабатывающая промышленность, нефтехимия
- Техническое обслуживание нефтепроводов
- Производство и транспортировка энергии (газ, электричество и т.д.)
- Судостроительные верфи
- Авиационный транспорт, аэропорты
- Производство лакокрасочных покрытий
- Производство взрывчатых веществ и воспламеняющихся материалов
- Арсеналы, хранение боеприпасов или взрывчатых материалов
- Области, требующие размагничивания инструментов (стружка,...)
- Сельское хозяйство - зернохранилища
- и т.д.

Правила безопасности

- Искробезопасный инструмент не является достаточной защитой от взрыва, необходимо что бы и другие предметы соответствовали требованиям работы в данной среде, например: одежда, перчатки, защитные очки и другие материалы.
- Температура поверхности инструмента не должна быть выше температуры существующей газовой среды.
- Инструменты из сплава бериллиевой бронзы (Cu-Be) не должны находиться в контакте с ацетиленом, так как в этой среде присутствует риск возникновения искры.
- Все инструменты из сплава бериллиевой бронзы (Cu-Be) как законченный продукт не представляют опасности для пользователя, однако при модификации инструмента возникает возможность нанесения вреда здоровью человека частицами или пылью сплава Cu-Be.



**GARANTIE
FACOM
GUARANTEE**



FACOM ADF

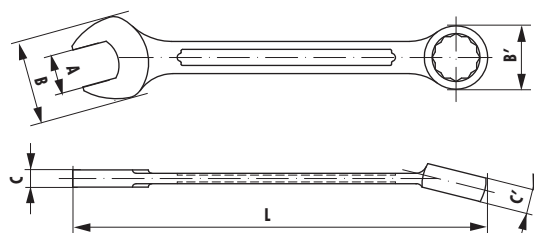
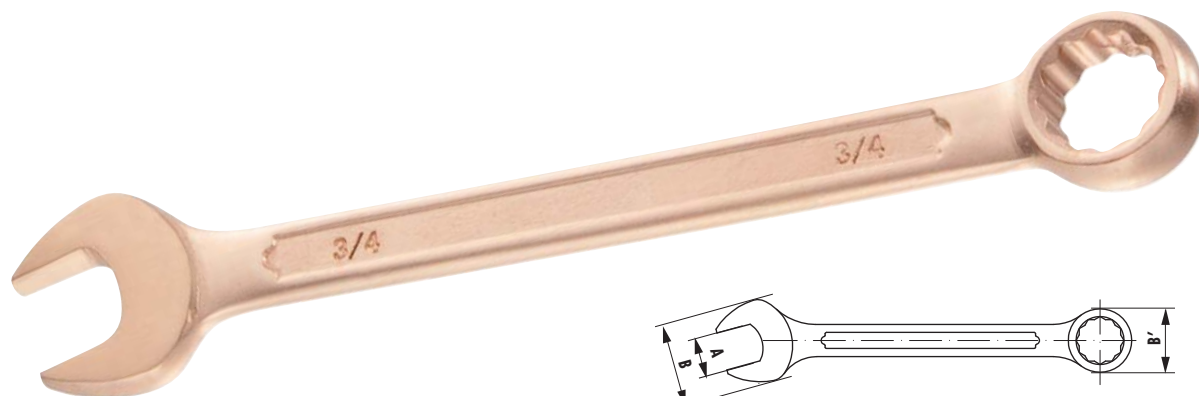

■ Metric combination wrench

- Clés mixtes métriques
- Llave combinada métrica
- Комбинированный ключ метрический

	A (mm)	B (mm)	B' (mm)	C (mm)	C' (mm)	L (mm)	g
440.6SR	6	14	11,60	4,40	6	105	22
440.7SR	7	17,5	14,50	5	7	120	22
440.8SR	8	17,5	14,50	5	7	120	37
440.9SR	9	22	18	5,40	8	135	37
440.10SR	10	22	18	5,40	8	135	55
440.11SR	11	26,5	21	6	9	150	55
440.12SR	12	26,5	21	6	9	150	75
440.13SR	13	30	23	6,60	10	175	75
440.14SR	14	30	23	6,60	10	175	122
440.15SR	15	35	27	7,60	11	175	122
440.16SR	16	35	27	7,60	11	195	155
440.17SR	17	35	27	7,60	11	195	155
440.18SR	18	39	31	8	12	215	210
440.19SR	19	39	31	8	12	215	210
440.20SR	20	45	34	9,50	13,50	230	225
440.21SR	21	45	34	9,50	13,50	230	225
440.22SR	22	46	36	9,40	14	245	250
440.23SR	23	46	38	9,40	14	245	250
440.24SR	24	49	38	10	15,20	265	260
440.25SR	25	49	38	9,40	15,20	265	260
440.26SR	26	56	38	10	17	290	420
440.27SR	27	56	42	11,40	17	290	420
440.30SR	30	61	49	13	20	320	560
440.32SR	32	65	52	14	21	340	670
440.34SR	34	72	52	15	21	360	850
440.35SR	35	72	55	15	21	360	890
440.36SR	36	72	55	15	21	360	890
440.38SR	38	82	64	15	21	430	1440
440.41SR	41	82	64	15	21	430	1440
440.46SR	46	90	70	16	22	480	1890
440.50SR	50	98	77	17	23	520	2220
440.55SR	55	108	83	18	23	560	2780
440.60SR	60	115	89	20	25	595	3230
440.65SR	65	125	95	21	27	595	3680
440.70SR	70	142	112	24	29	630	4770

■ Inch combination wrench

- Clés mixtes en pouces
- Llave combinada en pulgadas
- Комбинированный ключ дюймовый

	A (inch)	B (mm)	B' (mm)	C (mm)	C' (mm)	L (mm)	g
440.1/4SR	1/4"	14	11,60	4,40	6	105	22
440.5/16SR	5/16"	17,50	14,50	5	7	120	37
440.3/8SR	3/8"	22	18	5,40	8	135	55
440.7/16SR	7/16"	26,50	21	6	9	150	55
440.1/2SR	1/2"	30	23	6,60	10	175	75
440.9/16SR	9/16"	30	23	6,60	10	175	122
440.19/32SR	19/32"	35	27	7,60	11	195	122
440.5/8SR	5/8"	35	27	7,60	11	195	155
440.11/16SR	11/16"	35	27	7,60	11	195	155
440.3/4SR	3/4"	39	31	8	12	215	210
440.13/16SR	13/16"	45	34	9,50	13,50	230	225
440.7/8SR	7/8"	46	36	9,40	14	245	250
440.15/16SR	15/16"	49	38	10	15,20	265	260
440.1PSR	1"	56	42	11,40	17	290	260
440.1P1/16SR	1-1/16"	56	42	11,40	17	290	420
440.1P1/8SR	1-1/8"	61	49	13	20	320	560
440.1P3/16SR	1-3/16"	61	49	13	20	320	560
440.1P1/4SR	1-1/4"	65	52	14	21	340	670
440.1P5/16SR	1-5/16"	65	52	14	21	340	850
440.1P3/8SR	1-3/8"	72	55	15	21	360	890

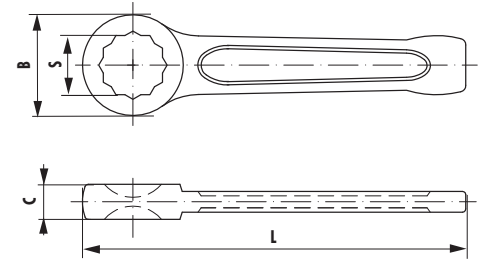

■ Metric slogging ring wrenches

- Clés à frapper polygonales métriques
- Llave de golpe poligonal métrica
- Ударный накидной ключ метрический

	S (mm)	B (mm)	C (mm)	L (mm)	g
50.17SR	17	32	12	145	210
50.19SR	19	32	12	145	200
50.22SR	22	42	14	165	245
50.24SR	24	42	14	165	235
50.27SR	27	46	16	175	350
50.30SR	30	53	16	185	475
50.32SR	32	53	16	185	465
50.34SR	34	58	19	205	580
50.36SR	36	58	19	205	580
50.38SR	38	64	20	225	790
50.41SR	41	64	20	225	755
50.46SR	46	73	22	235	990
50.50SR	50	78	23	250	1145
50.55SR	55	86	23,50	265	1440
50.60SR	60	92	25,50	274	1620
50.65SR	65	102	30	298	1995
50.70SR	70	108	31,50	320	2435
50.75SR	75	113	33	326	3010
50.80SR	80	124	34	350	3600
50.85SR	85	130	36	355	4330
50.90SR	90	142	39	390	5500
50.95SR	95	142	39	390	5450
50.100SR	100	155	43	420	7080
50.105SR	105	155	43	420	7000
50.110SR	110	168	45	450	9130
50.120SR	120	182	50	480	11000
50.130SR	130	200	57	520	12610
50.140SR	140	200	57	520	13000
50.150SR	150	220	58	565	14500

■ Inch slogging ring wrenches

- Clés à frapper polygonales en pouces
- Llave de golpe poligonal en pulgadas
- Ударный накидной ключ дюймовый

	S (inch)	B (mm)	C (mm)	L (mm)	g
50.11/16SR	11/16"	32	12	145	210
50.3/4SR	3/4"	32	12	145	200
50.7/8SR	7/8"	42	14	165	245
50.1PSR	1"	46	16	175	350
50.1P1/16SR	1-1/16"	46	16	175	350
50.1P1/8SR	1-1/8"	53	16	185	455
50.1P3/16SR	1-3/16"	53	16	185	475
50.1P1/4SR	1-1/4"	53	16	185	470
50.1P3/8SR	1-3/8"	58	19	205	560
50.1P1/2SR	1-1/2"	64	20	225	790
50.1P5/8SR	1-5/8"	64	20	225	755
50.1P3/4SR	1-3/4"	73	22	235	1020
50.1P13/16SR	1-13/16"	73	22	235	990
50.2PSR	2"	78	23	250	1145
50.2P1/16SR	2-1/16"	86	23,50	265	1145
50.2P3/16SR	2-3/16"	86	23,50	265	1350
50.2P13/64SR	2-13/64"	86	23,50	265	1350
50.2P5/16SR	2-5/16"	92	25,50	274	1620
50.2P3/8SR	2-3/8"	92	25,50	274	1620
50.2P1/2SR	2-1/2"	102	30	298	1900
50.2P9/16SR	2-9/16"	102	30	298	1900
50.2P5/8SR	2-5/8"	102	30	298	1900
50.2P3/4SR	2-3/4"	108	31,50	320	2270
50.2P15/16SR	2-15/16"	113	33	326	2680
50.3PSR	3"	113	33	326	2680
50.3P1/16SR	3-1/16"	124	34	350	2820
50.3P1/8SR	3-1/8"	124	34	350	2820
50.3P3/8SR	3-3/8"	130	36	355	4000
50.3P9/16SR	3-9/16"	142	39	390	5300
50.3P3/4SR	3-3/4"	142	39	390	5300
50.3P15/16SR	3-15/16"	155	43	420	6730
50.4P1/8SR	4-1/8"	155	43	420	6730



FACOM ADF

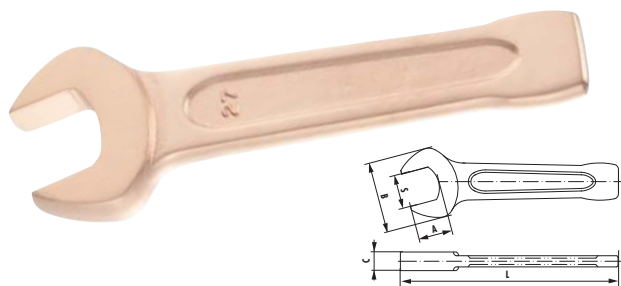

■ Metric open-end slogging wrench

- Clés à frapper à fourche métriques
- Llave fija de golpe métrica
- Ударный рожковый ключ метрический

Icon	S (mm)	A (mm)	B (mm)	C (mm)	L (mm)	g
Icon	17	17	40,5	12	125	150
49.17SR	17	17	40,5	12	125	150
49.19SR	19	19	40,5	12	125	150
49.22SR	22	22	46	12	135	195
49.24SR	24	24	50	12	150	245
49.27SR	27	27	57	15	175	335
49.30SR	30	30	64	15,5	190	435
49.32SR	32	32	66	16	190	515
49.36SR	36	36	75	17	210	725
49.38SR	38	38	82	18	220	955
49.41SR	41	41	87	18,5	230	955
49.46SR	46	46	98	20	250	1225
49.50SR	50	50	108	20,5	275	1340
49.52SR	52	52	108	20,5	275	1500
49.55SR	55	55	117	23	305	1665
49.60SR	60	60	128	23,5	315	2190
49.65SR	65	65	141	27,5	335	2670
49.70SR	70	70	156	28,5	370	3250
49.75SR	75	75	162	29	375	3660
49.80SR	80	80	174	32	400	4500
49.85SR	85	85	174	32	400	5290
49.90SR	90	90	194	36	445	6640
49.95SR	95	95	194	36	445	6640
49.100SR	100	100	228	43	485	8850
49.110SR	110	110	238	45	512	11060
49.120SR	120	120	253	51	530	11060
49.130SR	130	130	268	53	560	14800
49.140SR	140	140	268	53	560	15850
49.150SR	150	150	291	56	630	15850



■ Adjustable wrench

- Clés à molette
- Llave inglesa
- Разводной ключ с зубчатой рейкой

Icon	A (mm)	B (mm)	E (mm)	D (mm)	L (mm)	g
Icon	18	18	10,8	6,6	150	135
113A.6SR	18	18	10,8	6,6	150	135
113A.8SR	24	24	13,3	9	200	281
113A.10SR	30	28	15,7	10,5	250	440
113A.12SR	36	33	18,8	11,2	300	720
113A.15SR	46	42	23,4	13,7	375	1410
113A.18SR	55	51	26,7	15	450	2261

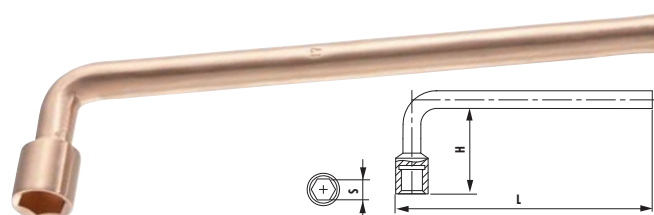

■ Metric socket wrench

- Clés à pipe métriques
- Llave de pipa métrica
- Метрический накидной торцовый ключ

Icon	S (mm)	H (mm)	L (mm)	g
Icon	6	29	120	100
75.6SR	6	29	120	100
75.8SR	8	33	145	150
75.10SR	10	37	168	200
75.12SR	12	42	215	220
75.13SR	13	45	240	250
75.14SR	14	45	245	300
75.15SR	15	48	250	350
75.16SR	16	48	255	500
75.17SR	17	51	260	550
75.18SR	18	53	265	550
75.19SR	19	55	270	550
75.20SR	20	57	272	600
75.21SR	21	57	275	750
75.22SR	22	59	278	750
75.23SR	23	60	282	800
75.24SR	24	63	286	850
75.27SR	27	69	294	900
75.30SR	30	75	302	1000
75.32SR	32	81	310	1100
75.36SR	36	85	330	1300
75.41SR	41	90	350	1380

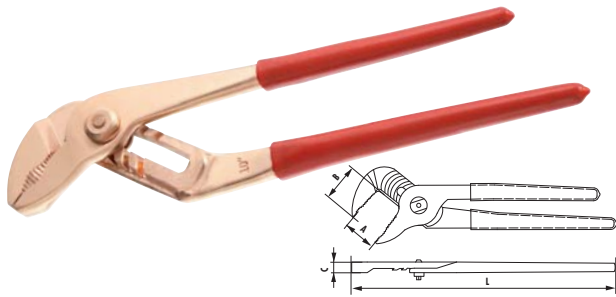

Sheathed multigrip pliers

- Pincas multiprises
- Alicates multitoma
- Переставные клещи

	A (mm)	B (mm)	C (mm)	L (mm)	g
482.15SR	25	30	8	150	150
482.25SR	45	36	10	250	453
482.30SR	55	52	11	300	745
482.35SR	55	52	11	350	790

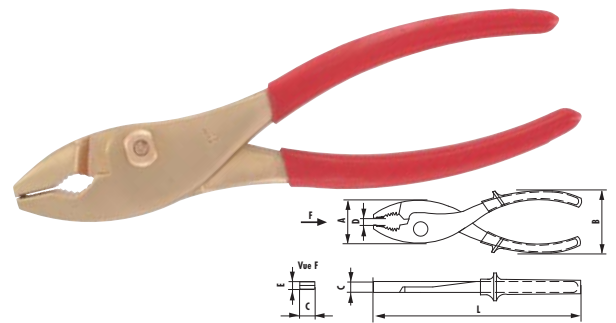

Sheathed motorists pliers

- Pincas motoristes
- Alicates de apertura múltiple con mangos revestidos
- Пассатижи типа "Моторист"

	A (mm)	B (mm)	C (mm)	D (mm)	E (mm)	L (mm)	g
186.7SR	27	40	9	8	6	150	213
186.8SR	29	64	12	13	8	200	323

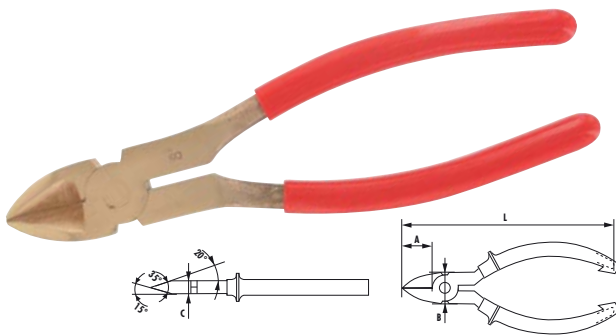

Pliers, diagonal cutting

- Pincas coupantes
- Alicates de corte diag
- Кусачки диагональные

	A (mm)	B (mm)	L (mm)	g
192.16SR	20	24	150	205
192.20SR	30	28	195	310

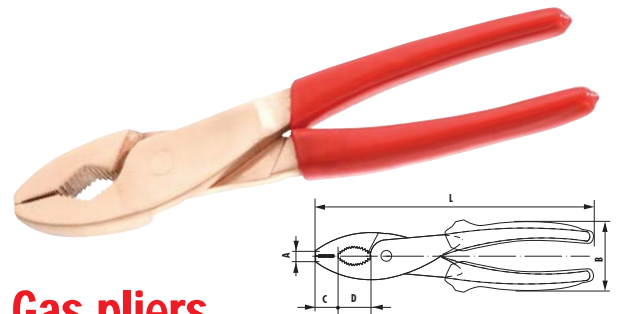

Gas pliers

- Pince gaz
- Alicates gaz
- Пассатижи

	A (mm)	B (mm)	C (mm)	D (mm)	L (mm)	g
186.9SR	7	47	17	24	200	350

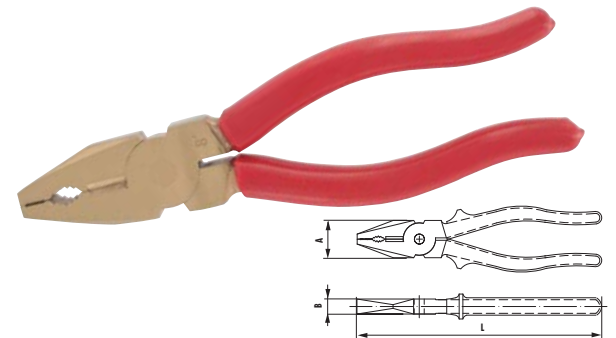

Lineman's pliers

- Pincas Lineman's
- Alicates Lineman's
- Комбинированные пассатижи

	A (mm)	B (mm)	L (mm)	g
187.16SR	24	11	150	180
187.18SR	28	12	175	306
187.20SR	28	12	195	405
187.22SR	32	13	250	502

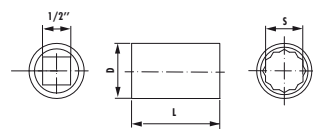

■ Metric 1/2" drive socket

- Douilles 1/2" métriques
- Vaso de 1/2" métrica
- Метрические головки 1/2"

	S (mm)	D max (mm)	L (mm)	g
S.6SR	6	24	40	75
S.7SR	7	24	40	77
S.8SR	8	24	40	77
S.9SR	9	24	40	78
S.10SR	10	24	40	78
S.11SR	11	24	40	79
S.12SR	12	24	40	79
S.13SR	13	24	40	80
S.14SR	14	24	40	80
S.15SR	15	25	40	82
S.16SR	16	25	40	85
S.17SR	17	25	40	88
S.18SR	18	26	42	90
S.19SR	19	28	42	110
S.20SR	20	29	43	120
S.21SR	21	30	43	137
S.22SR	22	31	43	143
S.23SR	23	33	43	159
S.24SR	24	34	43	186
S.25SR	25	36	43	197
S.26SR	26	37	43	207
S.27SR	27	38	46	235
S.28SR	28	39	46	245
S.29SR	29	41	46	250
S.30SR	30	42	46	285
S.32SR	32	44	46	320

■ Inch 1/2" drive socket

- Douilles 1/2" en pouces
- Vaso de 1/2" en pulgadas
- Дюймовые головки 1/2"

	S (inch)	D max (mm)	L (mm)	g
S.5/16SR	5/16"	24	40	78
S.3/8SR	3/8"	24	40	78
S.7/16SR	7/16"	24	40	79
S.1/2SR	1/2"	24	40	79
S.9/16SR	9/16"	24	40	80
S.5/8SR	5/8"	24	40	88
S.11/16SR	11/16"	26	40	93
S.3/4SR	3/4"	28	42	99
S.13/16SR	13/16"	30	43	120
S.7/8SR	7/8"	32	43	142
S.15/16SR	15/16"	34	43	148
S.1PSR	1"	36	43	159
S.1P1/16SR	1-1/16"	38	46	241
S.1P1/4SR	1-1/4"	43	46	276
S.1P7/16SR	1-7/16"	49	47	308

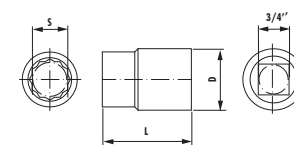

■ Metric 3/4" drive socket

- Douilles 3/4" métriques
- Vaso de 3/4" métrica
- Метрические головки 3/4"

	S (mm)	D max (mm)	L (mm)	g
K.17SR	17	38	50	246
K.19SR	19	38	50	246
K.21SR	21	38	55	268
K.22SR	22	38	55	268
K.23SR	23	40	55	306
K.24SR	24	40	55	307
K.26SR	26	40	55	307
K.27SR	27	40	55	312
K.28SR	28	40	55	339
K.29SR	29	40	55	350
K.30SR	30	43	60	410
K.32SR	32	45	60	465
K.34SR	34	45	60	480
K.36SR	36	45	60	510
K.38SR	38	46	60	555
K.41SR	41	48	65	660
K.46SR	46	50	65	830
K.50SR	50	50	70	945

■ Inch 3/4" drive socket

- Douilles 3/4" en pouces
- Vaso de 3/4" en pulgadas
- Дюймовые головки 3/4"

	S (inch)	D max (mm)	L (mm)	g
K.3/4SR	3/4"	38	50	240
K.13/16SR	13/16"	38	55	262
K.7/8SR	7/8"	38	55	267
K.15/16SR	15/16"	40	55	305
K.1PSR	1"	40	55	310
K.1P1/16SR	1-1/16"	40	55	315
K.1P1/8SR	1-1/8"	43	55	245
K.1P3/16SR	1-3/16"	44	60	400
K.1P1/4SR	1-1/4"	46	60	437
K.1P5/16SR	1-5/16"	48	60	472
K.1P3/8SR	1-3/8"	50	60	515
K.1P7/16SR	1-7/16"	52	60	525
K.1P1/2SR	1-1/2"	54	60	580
K.1P5/8SR	1-5/8"	58	65	702
K.1P3/4SR	1-3/4"	62	65	761
K.1P13/16SR	1-13/16"	64	65	830
K.1P7/8SR	1-7/8"	66	65	850
K.2PSR	2"	69	70	930

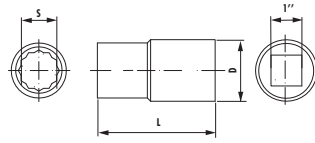

■ Metric 1" drive socket

- Douilles 1" métriques
- Vaso de 1" métrica
- Метрические головки 1"

	S (mm)	D max (mm)	L (mm)	g
M.22SR	22	48	55	361
M.24SR	24	48	55	372
M.26SR	26	48	55	383
M.27SR	27	48	55	394
M.28SR	28	48	55	397
M.29SR	29	48	55	399
M.30SR	30	48	60	443
M.31SR	31	48	60	448
M.32SR	32	48	60	481
M.34SR	34	50	60	497
M.36SR	36	52	60	505
M.38SR	38	55	60	568
M.41SR	41	58	65	630
M.46SR	46	64	65	785
M.50SR	50	68	70	890
M.55SR	55	74	75	1090
M.60SR	60	81	75	1220
M.65SR	65	88	80	1455
M.70SR	70	95	80	1550
M.75SR	75	103	80	2160
M.80SR	80	110	85	2405

■ Inch 1" drive socket

- Douilles 1" en pouces
- Llave de vaso de 1" en pulgadas
- Дюймовые головки 1"

	S (inch)	D max (mm)	L (mm)	g
M.1P1/16SR	1-1/16"	48	55	394
M.1P1/8SR	1-1/8"	48	55	398
M.1P3/16SR	1-3/16"	48	60	442
M.1P1/4SR	1-1/4"	48	60	470
M.1P5/16SR	1-5/16"	48	60	483
M.1P3/8SR	1-3/8"	50	60	490
M.1P7/16SR	1-7/16"	52	60	520
M.1P1/2SR	1-1/2"	55	60	562
M.1P5/8SR	1-5/8"	58	65	633
M.1P7/8SR	1-7/8"	66	65	778
M.2PSR	2"	68	70	910
M.2P1/4SR	2-1/4"	77	75	1192
M.2P1/2SR	2-1/2"	85	75	1375
M.2P3/4SR	2-3/4"	95	80	1505
M.3PSR	3"	104	80	1670



p10

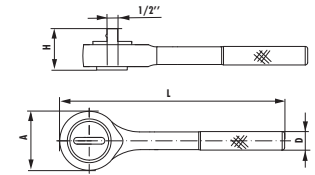
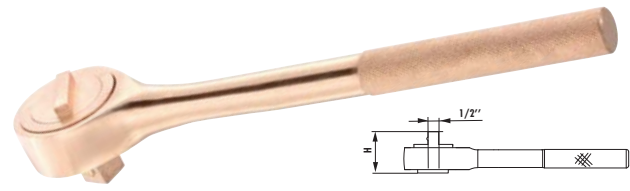

■ 1/2" to 1" drive ratchet

- Cliquets 1/2" à 1"
- Trinquete de 1/2" a 1"
- Трещотки с приводным квадратом от 1/2" до 1"

	Square (inch)	A (mm)	D (mm)	H (mm)	L (mm)	g
S.155SR	1/2"	48	17	43	245	690
K.149SR	3/4"	70	21	57	320	1570
M.151SR	1"	84	26	67	550	3400

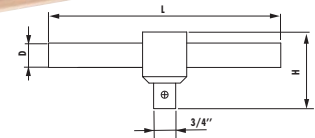
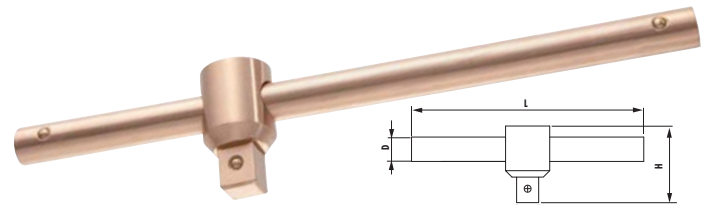

■ 1/2" to 1" drive sliding handle

- Poignées coulissantes 1/2" à 1"
- Mango corredizo en T de 1/2" a 1"
- Скользящие воротки с приводным квадратом от 1/2" до 1"

	Square (inch)	D (mm)	H (mm)	L (mm)	g
S.120SR	1/2"	13	39	250	330
K.120SR	3/4"	21	56	400	1335
M.120SR	1"	21	62	400	1620

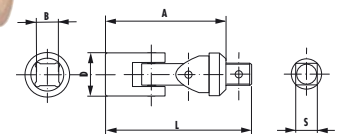

■ 1/2" to 1" Universal joints

- Cardans 1/2" à 1"
- Cardans de 1/2" a 1"
- Кардан универсальный от 1/2" до 1"

	Square (inch)	L (mm)	A (mm)	B (mm)	D (mm)	S (mm)	g
S.240SR	1/2"	80	65	12,7	25	12,7	186
K.240SR	3/4"	112	90	19	38	19	500
M.240SR	1"	130	95	25,4	48	25,4	1000



FACOM ADF

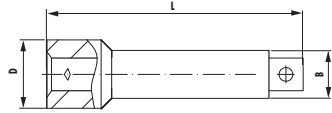
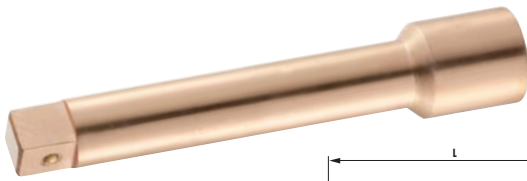

■ 1/2" to 1" drive extension

- Rallonges 1/2" à 1"
- Alargadera de 1/2" a 1"
- Удлинитель с присоединительным квадратом от 1/2" до 1"

	Square (inch)	D (mm)	B (mm)	L (mm)	g
S.208SR	1/2"	25	18	100	245
S.210SR	1/2"	25	18	125	260
S.212SR	1/2"	25	18	200	485
S.215SR	1/2"	25	18	250	510
K.210SR	3/4"	35	25	200	960
M.210SR	1"	46	36	200	1580

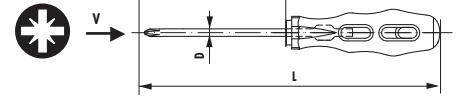
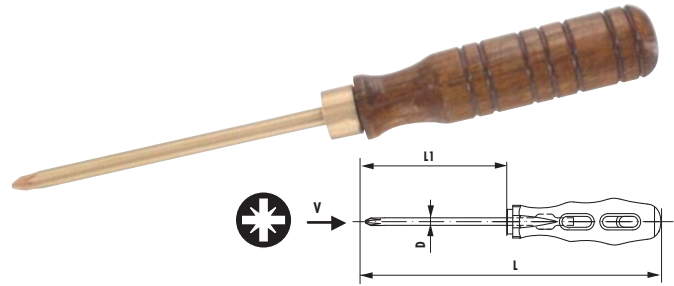

■ Screwdriver for Pozidriv® heads

- Tournevis pour vis Pozidriv®
- Destornillador de boca Pozidriv®
- Отвертки крестовые с профилем Pozidriv®

	Pozidriv®	D (mm)	L1 (mm)	L (mm)	g
AND0X75SR	0	3	50	132	35
AND1X75SR	1	4,50	75	157	45
AND2X100SR	2	6	100	200	85
AND3X150SR	3	8	150	262	145
AND4X200SR	4	10	200	312	230

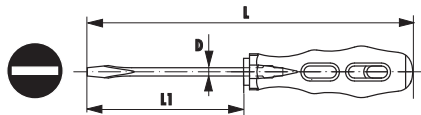

■ Screwdriver for slotted heads

- Tournevis pour vis à fente
- Destornillador de boca plana
- Отвертки шлицевые

	D (mm)	L1 (mm)	L (mm)	g
AN3X50SR	2	50	132	35
AN4.5X50SR	2	50	132	43
AN3X75SR	3	75	157	35
AN4X75SR	3	75	157	45
AN4X50SR	4	100	182	45
AN5X100SR	4	100	203	75
AN6X100SR	4	100	203	85
AN6X150SR	6	125	203	110
AN7X150SR	6	150	237	125
AN8X150SR	6	150	262	140
AN8X200SR	8	150	262	165
AN9X250SR	10	200	262	185
AN11X250SR	10	250	312	260
AN10X300SR	12	250	362	245
AN11X350SR	14	350	462	320
AN12X400SR	16	400	550	450
AN13X450SR	18	450	600	530

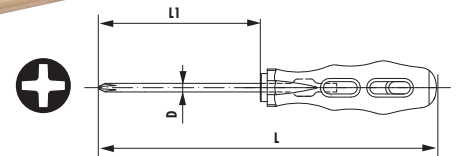
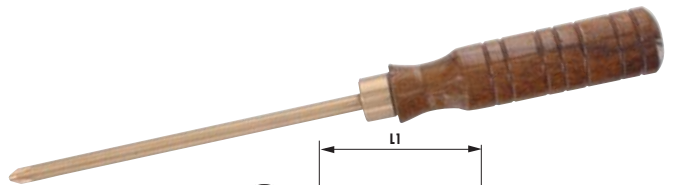

■ Screwdriver for Phillips® heads

- Tournevis pour vis Phillips®
- Destornillador de boca Phillips®
- Отвертки крестовые с профилем Phillips®

	Phillips®	D (mm)	L1 (mm)	L (mm)	g
ANP0X50SR	0	3	50	132	35
ANP1X75SR	1	4	75	178	70
ANP1X100SR	1	5	100	203	75
ANP2X100SR	2	6	125	225	100
ANP2X125SR	2	6	150	262	110
ANP3X150SR	3	8	200	312	165
ANP4X200SR	4	8	250	362	185
ANP4X300SR	4	9	300	415	245
ANP4X400SR	4	9	400	550	295

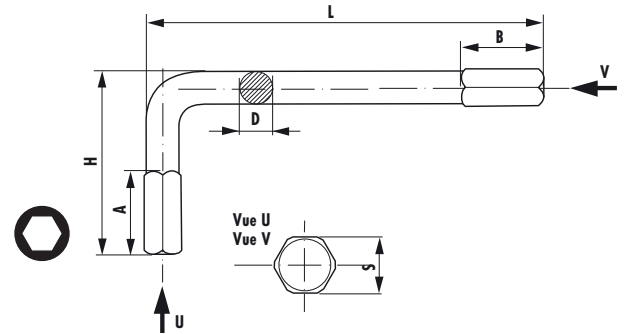
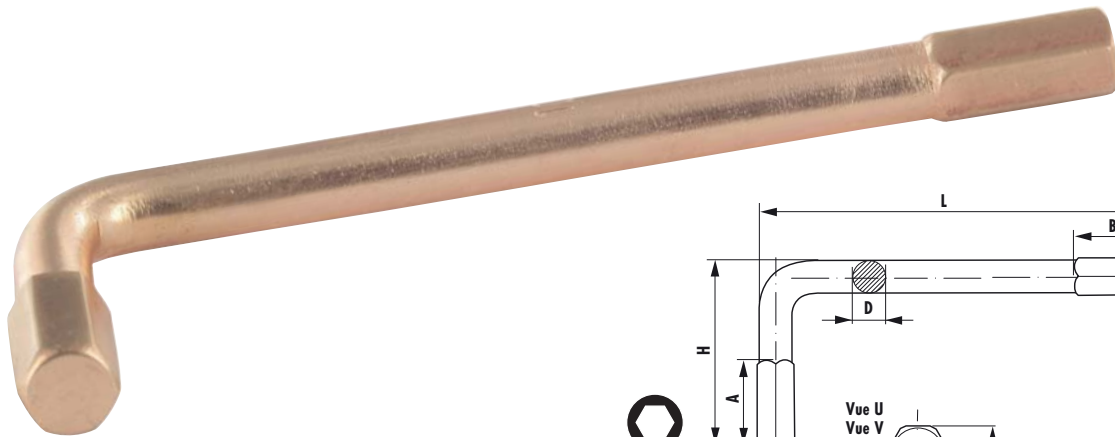

Hex keys metric

- Clés mâles métriques
- Llaves macho métrica
- Шестигранные угловые торцовые ключи метрические

	S (mm)	L (mm)	H (mm)	A (mm)	B (mm)	D (mm)	g
82H.1.5SR	1,5	38	13	5	5	3	6
82H.2SR	2	38	13	5	5	3	6
82H.3SR	3	59	25	7	7	3,7	8
82H.4SR	4	65	30	10	10	3,8	10
82H.5SR	5	79	32	10	10	4,5	16
82H.6SR	6	85	37	15	15	5,5	25
82H.7SR	7	88	43	20	20	6	34
82H.8SR	8	92	44	20	20	7	50
82H.9SR	9	97	44	20	20	8	61
82H.10SR	10	110	45	20	20	9	82
82H.11SR	11	119	48	20	20	10	100
82H.12SR	12	130	52	20	20	11	145
82H.13SR	13	140	54	20	20	11,5	180
82H.14SR	14	150	58	25	25	12	211
82H.16SR	16	162	63	25	25	14	300
82H.17SR	17	168	65	30	30	15	370
82H.18SR	18	173	69	30	30	16	450
82H.19SR	19	177	72	30	30	17	490
82H.22SR	22	186	77	35	35	20	675
82H.23SR	23	189	80	35	35	21	723
82H.24SR	24	192	82	35	35	22	825
82H.27SR	27	213	93	35	35	25	1220
82H.32SR	32	266	116	40	40	30	2065
82H.36SR	36	294	128	40	40	34	2905
82H.41SR	41	320	140	40	40	39	4120

Hex keys inch

- Clés mâles en pouces
- Llaves macho pulgadas
- Шестигранные угловые торцовые ключи дюймовые

	S (mm)	L (mm)	H (mm)	A (mm)	B (mm)	g
82H.1/16SR	1/16"	38	13	5	5	6
82H.5/64SR	5/64"	38	13	5	5	6
82H.3/32SR	3/32"	38	13	6	6	6
82H.7/64SR	7/64"	58	24	7	7	8
82H.1/8SR	1/8"	58	24	7	7	8
82H.9/64SR	9/64"	64	29	10	10	8
82H.5/32SR	5/32"	65	30	10	10	10
82H.3/16SR	3/16"	79	31	10	10	15
82H.7/32SR	7/32"	85	37	15	15	20
82H.1/4SR	1/4"	85	37	15	15	30
82H.9/32SR	9/32"	88	43	20	20	45
82H.5/16SR	5/16"	92	44	20	20	48
82H.11/32SR	11/32"	97	44	20	20	50
82H.3/8SR	3/8"	110	45	20	20	85
82H.7/16SR	7/16"	119	48	20	20	110
82H.1/2SR	1/2"	140	55	20	20	170
82H.9/16SR	9/16"	150	58	25	25	195
82H.5/8SR	5/8"	162	63	25	25	270
82H.11/16SR	11/16"	168	65	30	30	355
82H.3/4SR	3/4"	178	73	30	30	450
82H.13/16SR	13/16"	184	77	35	35	565
82H.7/8SR	7/8"	187	79	35	35	650
82H.15/16SR	15/16"	192	82	35	35	825
82H.1PSR	1"	200	85	35	35	925
82H.1P1/16SR	1-1/16"	213	93	35	35	1220
82H.1P1/8SR	1-1/8"	230,5	99,5	35	35	1350
82H.1P3/16SR	1-3/16"	239	104	40	40	1615
82H.1P1/4SR	1-1/4"	265	115	40	40	2065
82H.1P7/16SR	1-7/16"	303	132	40	40	2905
82H.1P5/8SR	1-5/8"	319,5	139,5	40	40	4120



FACOM ADF

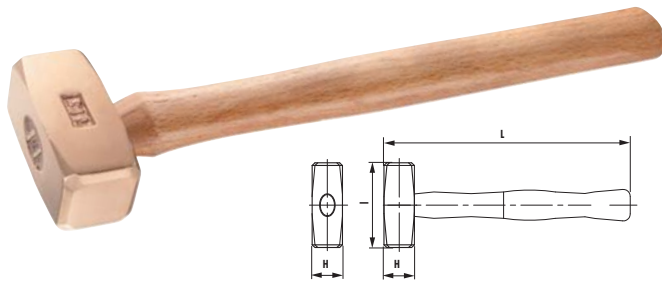

German style club hammer

- Masses modèle allemand
- Maza modelo alemán
- Молотки немецкого типа



	l (mm)	H (mm)	L (mm)	g
1262H.50SR	80	30	250	650
1262H.100SR	95	40	250	1300
1262H.150SR	118	42	250	1800
1262H.200SR	126	48	250	2300
1262H.400SR	165	58	800	4900
1262H.500SR	178	62	800	5900

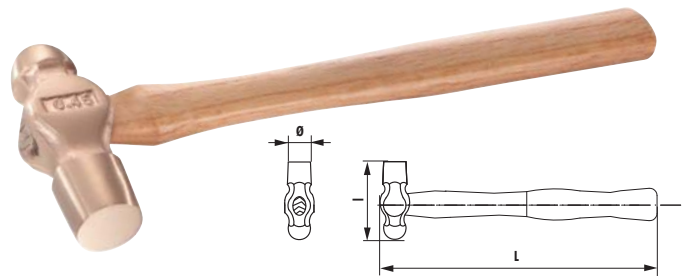

Ball pein hammer

- Marteaux à tête ronde
- Martillo de bola
- Молоток с круглым бойком



	l (mm)	Ø (mm)	L (mm)	g
202H.1/4SR	80	23	300	403
202H.1/2SR	90	26	300	502
202H.1SR	101	28	320	680
202H.1P1/4SR	115	33	366	950
202H.1P1/2SR	126	35	366	1205
202H.2SR	137	37	397	1470

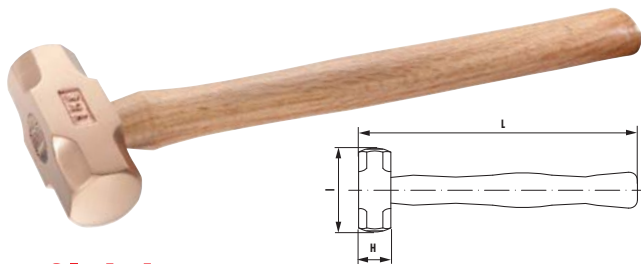

Club hammer

- Masses
- Maza
- Кувалды



	l (mm)	H (mm)	L (mm)	g
1261H.45SR	85	29	250	610
1261H.100SR	105	40	250	1300
1261H.140SR	116	43	250	1700
1261H.150SR	122	43	250	1800
1261H.180SR	126	48	250	2100
1261H.200SR	130	48	250	2300
1261H.220SR	142	51	250	2500
1261H.250SR	149	51,50	258	3410
1261H.270SR	153	53	258	3610
1261H.300SR	157	55	700	3910
1261H.400SR	166	61	800	4910
1261H.450SR	178	63,50	800	5410
1261H.500SR	182	65	800	5910
1261H.540SR	183	68	800	6310
1261H.640SR	193	70,50	800	7310
1261H.800SR	208	75	900	8910
1261H.820SR	210	76,50	900	9110
1261H.990SR	222	81	900	10810

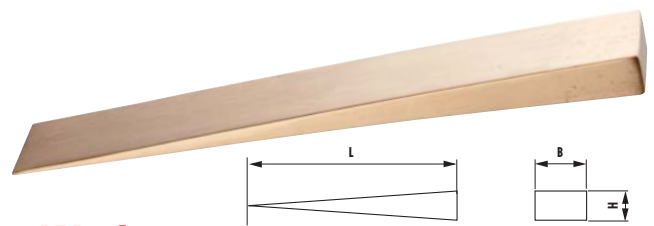

Wedge

- Coins
- Cuña
- Клин



	L (mm)	B (mm)	H (mm)	g
WF80.13SR	80	13	6	25
WF100.50SR	100	50	10	201
WF135.50SR	135	50	18	497
WF150.40SR	150	40	8	200
WF150.25SR	150	25	8	122
WF150.26SR	150	25	13	205
WF150.30SR	150	50	13	400
WF180.32SR	180	32	13	305
WF180.50SR	180	50	19	700
WF200.20SR	200	20	30	490
WF200.30SR	200	30	30	740
WF200.40SR	200	40	40	1315
WF200.50SR	200	50	12	500
WF230.40SR	230	40	20	751
WF250.40SR	250	40	30	1230
WF300.50SR	300	50	40	2460



■ Chisel

- Burins
- Butil
- Зубила



	S (mm)	L (mm)	B (mm)	g
265.20SR	10	150	12	98
265.22SR	12	160	14	240
265.24SR	14	200	16	251
265.26SR	16	160	18	262
265.28SR	17	350	19	903
265.29SR	22	600	24	1861
263.30SR	25	300	28	1204
263.32SR	30	300	35	2860

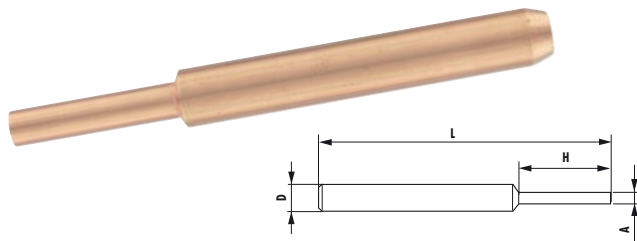

■ Drifts cylindrical

- Chasse-goupilles
- Botaspasadores
- Выколотки цилиндрические



	A (mm)	L (mm)	H (mm)	D (mm)	g
249.3SR	3	110	20	9	20
249.4SR	4	110	35	10	57
249.6SR	6	115	35	12	105
249.8SR	8	120	40	14	130
249.10SR	10	145	45	16	200
249.12SR	12	160	50	18	280

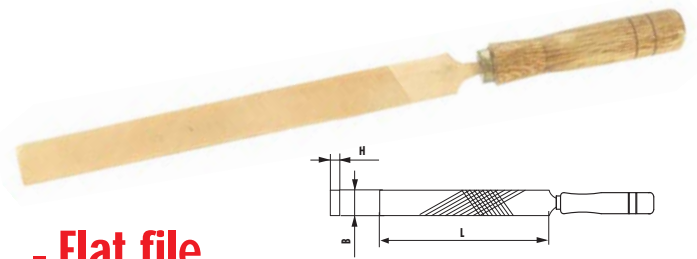

■ Flat file

- Limes plates
- Lima plana
- Плоский напильник

	L (mm)	H (mm)	B (mm)	g
PAM.MD150SR	150	4	16	75
PAM.MD200SR	200	4,50	21	160
PAM.MD250SR	250	6	25	282
PAM.MD300SR	300	6,50	30	455
PAM.D350SR	350	8	32	675
PAM.D400SR	400	9,50	32	925

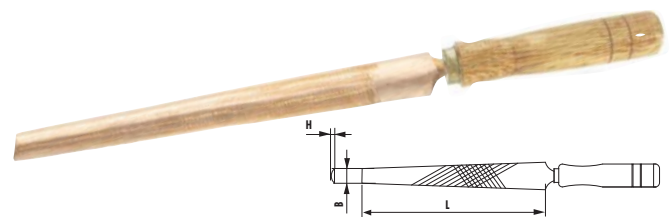

■ Half-round file

- Limes demi-rondes
- Lima de media caña
- Полукруглый напильник

	L (mm)	H (mm)	B (mm)	g
DRD.MD200SR	150	4	15	105
DRD.MD220SR	200	4	17	190
DRD.MD250SR	250	5	17	255
DRD.MD300SR	300	5	17	375
DRD.MD350SR	350	6	17	565

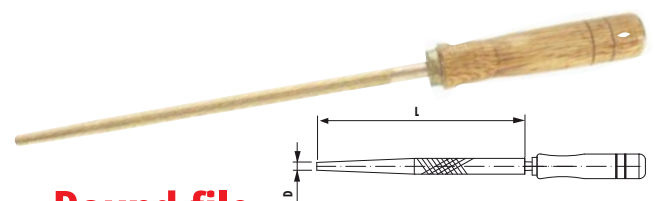

■ Round file

- Limes rondes
- Lima redonda
- Круглый напильник

	L (mm)	D (mm)	g
RD.MD150SR	150	5,50	45
RD.MD200SR	200	6	91
RD.MD250SR	250	6,50	122
RD.MD300SR	300	7	180
RD.MD350SR	350	7,50	250



FACOM ADF

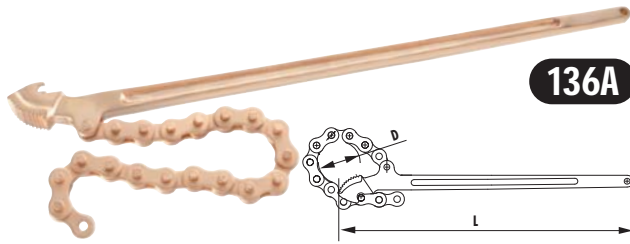

136A

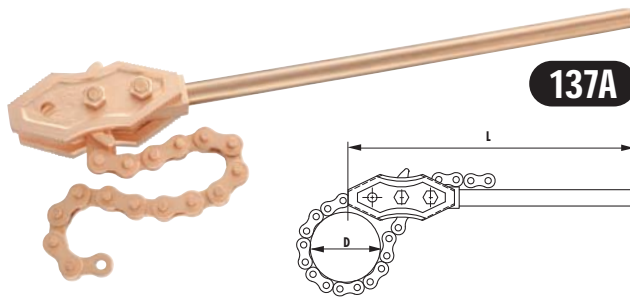

137A

Chain pipe wrench

- Clés serre tube à chaîne
- Llave de cadena
- Цепной трубный ключ

	D (mm)	L (mm)	g
136A.2SR	100	600	2105
137A.2P1/2SR	100	600	3955
137A.4PSR	150	600	4475
137A.6PSR	200	900	8705

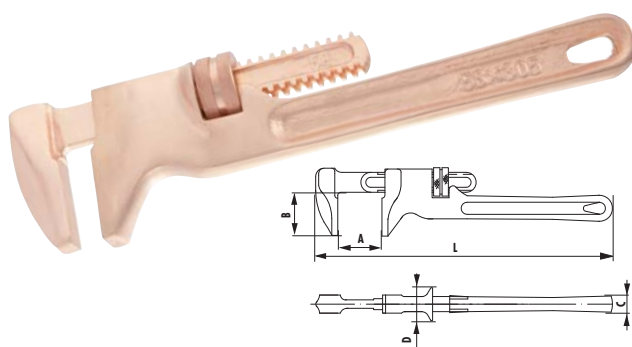

Monkey wrench

- Clés à crémaillère
- Llave de cremallera
- Разводной гаечный ключ

	A (mm)	B (mm)	C (mm)	D (mm)	L (mm)	g
134A.8SR	45	35,50	12	26	240	510
134A.10SR	48	35,50	12	26	254	615
134A.12SR	58	43	15	32	305	1180
134A.14SR	65	49,50	18	36	350	1220

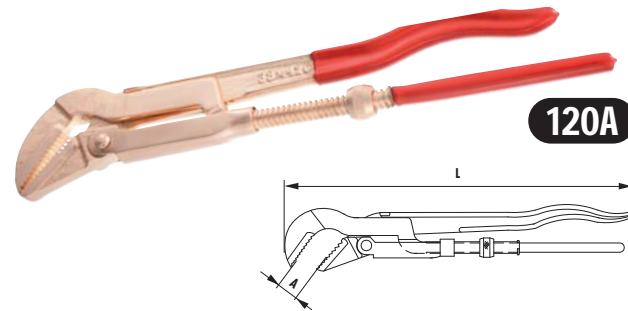

120A

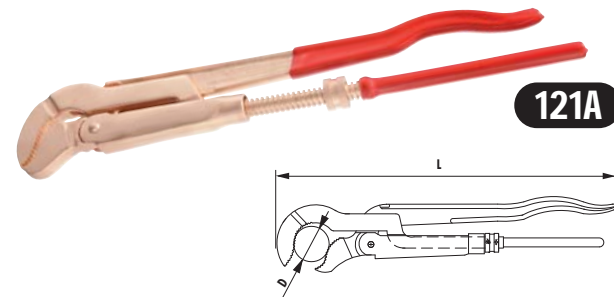

121A

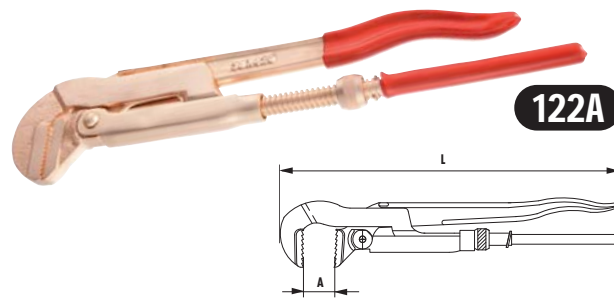

122A

Swedish model pipe wrench

- Clés serre tube modèle suédois
- Llave grifa o Stillson modelo sueco
- Трубный ключ шведского типа

	A (mm)	D (mm)	L (mm)	g
120A.1P1/2SR	38	-	420	1427
120A.2PSR	50	-	530	1755
122A.2PSR	38	-	420	1500
121A.2PSR	-	50	530	2605

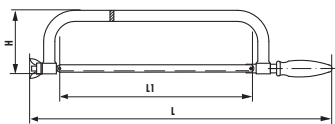

Saw

- Monture de scie
- Sierra
- Ножовка

	L (mm)	L1 (mm)	H (mm)	g
599SR	500	300	103	645

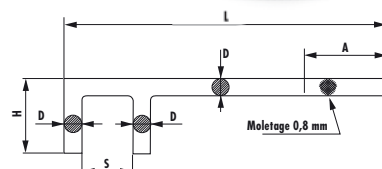

Valve handles

- Clés à valve
- Llave de valvula
- Ключ для клапанов

	L (mm)	H (mm)	A (mm)	S (mm)	D (mm)	g
VH30.200SR	200	44	100	30	13	280
VH32.300SR	300	50	120	32	15	540
VH35.250SR	250	47	110	35	13	364
VH40.300SR	300	50	120	40	14	470
VH45.350SR	350	58	130	45	15	610
VH48.375SR	375	62	140	48	15	660
VH50.400SR	400	67	150	50	15,5	705
VH55.450SR	450	73	160	55	16,5	960
VH60.500SR	500	79	170	60	17,5	1205
VH65.550SR	550	82	180	65	18	1370
VH70.600SR	600	85	190	70	18	1540
VH75.650SR	650	88	200	75	18,5	1705
VH80.700SR	700	91	210	80	19	1910
VH85.750SR	750	97	220	85	20	2250
VH90.800SR	800	103	230	90	20	2380

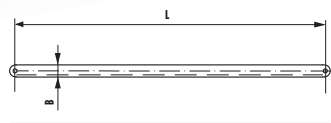
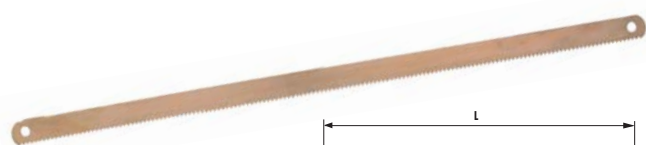

Hacksaw blade

- Lame de scie
- Hojas de sierra de mano
- Ножовочное полотно

	L (mm)	B (mm)	g
660A.10SR	300	12	32

Specific instructions for non sparking tools

FACOM warranty is applied to the non sparking tools range.

The performance of the alloy used (Copper-Beryllium) is inferior to steel alloy and requires special attention for use, in particular for sharp tools (cutting pliers, chisel). It is recommended to check before use, the compatibility of the tool in respect of the work application, to abide by the FACOM warranty policy.

Specificité des outils antidéflagrants

La garantie FACOM s'applique aux outils de la gamme antidéflagrante.

Les performances de l'alliage utilisé (Cuivre-Béryllium), inférieures à celle de l'acier, nécessitent toutefois un usage approprié, notamment pour les outils coupants (Pincers, Burins...). Il convient donc de vérifier préalablement à chaque usage le bon respect des capacités fonctionnelles de chaque outil, afin de demeurer dans le cadre de la garantie FACOM.

Especificidad de las herramientas antichispas

La garantía FACOM se aplica a las herramientas de la gama antichispa.

Las prestaciones de la aleación utilizada (cobre-berilio), inferiores a las del acero, necesitan sin embargo un uso apropiado, en particular para las herramientas de corte (alicates, cortafíos...). En consecuencia, es conveniente verificar, antes de cada uso, el respeto de las capacidades funcionales de cada herramienta, con el fin de mantenerse dentro del marco de la garantía FACOM.

Специальные инструкции для искробезопасного инструмента

На искробезопасный инструмент распространяется гарантия FACOM. Характеристики применяемого сплава Бериллиевой бронзы несколько ниже чем для стали, что требует особого внимания при применении искробезопасного инструмента, в частности инструмента с острыми гранями (бокорезы, зубило и т.д.). В соответствии с гарантийной политикой FACOM перед использованием инструмента рекомендуется проверить его соответствие условиям работы.

FACOM ADF

Non-sparking tools



Besides the range of non sparking tools in its catalog, FACOM can study any request of specific tools.

Consult your FACOM representative or your local dealer.

En plus du programme d'outillage antidéflagrant de son catalogue, FACOM peut étudier toute demande d'outils complémentaires.

Consultez votre représentant FACOM ou votre distributeur.

Además de su programa de herramientas antifichispa en su catálogo, FACOM puede estudiar cualquier solicitud de herramienta complementaria.

Contacte con su representante FACOM o con su distribuidor.

Кроме указанного в данном каталоге перечня искробезопасного инструмента, компания FACOM готова рассмотреть Ваш запрос на специфичные виды инструментов. Проконсультируйтесь с.

Проконсультируйтесь с вашим представителем FACOM или дистрибьютором.



Pro for life

www.facom.com